

Плоскошовные швейные машины се ии LS

е ни еские а ак е ис ики

По вопросам продаж и поддержки обращайтесь:

Алматы (7273)495-231
Архангельск (8182)63-90-72
Астрахань (8512)99-46-04
Барнаул (3852)73-04-60
Белгород (4722)40-23-64
Брянск (4832)59-03-52
Владивосток (423)249-28-31
Волгоград (844)278-03-48
Вологда (8172)26-41-59
Воронеж (473)204-51-73
Екатеринбург (343)384-55-89
Иваново (4932)77-34-06
Ижевск (3412)26-03-58
Иркутск (395)279-98-46
Россия (495)268-04-70

Казань (843)206-01-48
Калининград (4012)72-03-81
Калуга (4842)92-23-67
Кемерово (3842)65-04-62
Киров (8332)68-02-04
Краснодар (861)203-40-90
Красноярск (391)204-63-61
Курск (4712)77-13-04
Липецк (4742)52-20-81
Магнитогорск (3519)55-03-13
Москва (495)268-04-70
Мурманск (8152)59-64-93
Набережные Челны (8552)20-53-41
Нижний Новгород (831)429-08-12
Киргизия (996)312-96-26-47

Новокузнецк (3843)20-46-81
Новосибирск (383)227-86-73
Омск (3812)21-46-40
Орел (4862)44-53-42
Оренбург (3532)37-68-04
Пенза (8412)22-31-16
Пермь (342)205-81-47
Ростов-на-Дону (863)308-18-15
Рязань (4912)46-61-64
Самара (846)206-03-16
Санкт-Петербург (812)309-46-40
Саратов (845)249-38-78
Севастополь (8692)22-31-93
Симферополь (3652)67-13-56
Казахстан (7172)727-132

Смоленск (4812)29-41-54
Сочи (862)225-72-31
Ставрополь (8652)20-65-13
Сургут (3462)77-98-35
Тверь (4822)63-31-35
Томск (3822)98-41-53
Тула (4872)74-02-29
Тюмень (3452)66-21-18
Ульяновск (8422)24-23-59
Уфа (347)229-48-12
Хабаровск (4212)92-98-04
Челябинск (351)202-03-61
Череповец (8202)49-02-64
Ярославль (4852)69-52-93



LS 9520MX-TD3-High Speed Computerized Lockstitch Sewing Machine with Knife

Lockstitch machine series



Independent research and development of electronic control



Advanced cutter mechanism



Switching the cutting knife, fast and convenient



Realize all the functions of the computer flat car



LS 9520DP-QB-Direct drive side cutter overlock sewing machine

Lockstitch machine series

LS 9520DP-QB	DRX1 11#-18#	5	S/13	1	★	3.2	★	4.0	★	5000	29/40	58*26*53



Needle repair function



hemming mechanism



Advanced cutter mechanism



Independent research and development of electronic control

LS 9520DP-Direct Drive Side Knife Lockstitch Sewing Machine

Lockstitch machine series



LS 9520DP	DBX1 11#-18#	5	5/13	★	1	3.2	-	★	★	4.0	5000	29/40	58*26*53



Needle repair function



Switching the cutting knife, fast and convenient



Independent research and development of electronic control



Advanced cutter mechanism



LS 8720EZN-D3-Computerized Double Needle Lockstitch Sewing Machine

Lockstitch machine series

LS 8720EZN-D3	DPX5 14-22#	7	7/13	★	★	★	33.4	★	6.4	★	★	★	★	★	-	★	3000	59.1/57.9	74*33.2*66.6
LS 8750EZN-D3	DPX5 14-22#	7	7/13	★	★	★	33.4	★	6.4	-	-	★	★	-	★	3000	59.1/57.9	74*33.2*66.6	
LS 8420EZN-D3-3	DPX5 14-22#	4	7/13	★	★	★	33.4	★	6.4	-	-	★	★	★	-	3000	59.1/57.9	74*33.2*66.6	
LS 8420EZN-D3-5	DPX5 14-22#	5	7/13	★	★	★	33.4	★	6.4	-	-	★	★	★	-	3000	59.1/57.9	74*33.2*66.6	
LS 8450EZN-D3-3	DPX5 14-22#	4	7/13	★	★	★	33.4	★	6.4	-	-	★	★	★	-	3000	59.1/57.9	74*33.2*66.6	
LS 8450EZN-D3-5	DPX5 14-22#	5	7/13	★	★	★	33.4	★	6.4	-	-	★	★	★	-	3000	59.1/57.9	74*33.2*66.6	



USB smart port Voice navigation One-click direct

Provide continuous power service for various USB products,
Electronic control settings can also be upgraded



Four automatic presser foot lifters

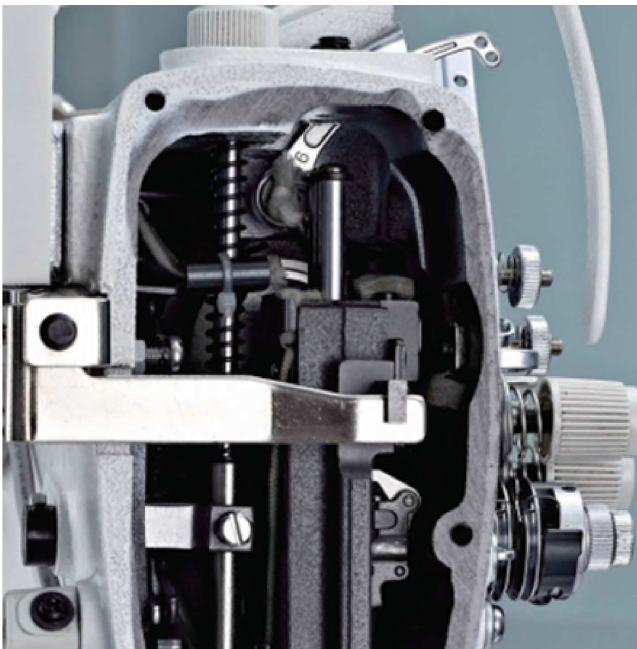

Micro oil for head

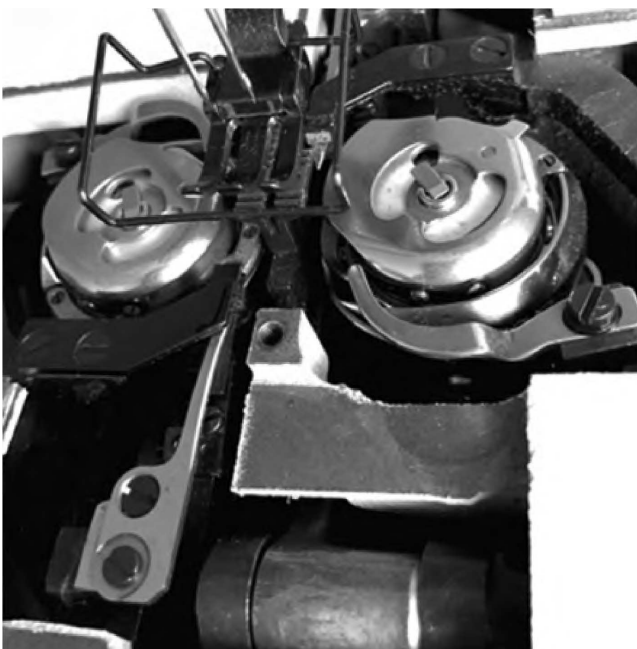

Straight knife



LS 8420DP-5-Simple Integrated Double Needle Lockstitch Sewing Machine

Lockstitch machine series

LS 8420DP-5	DPX5 14-22#	5	7/10	★	-	-	33.4	★	6.4	★	★	★	★	★	★	-	3000	59.1/57.9	74*33.2*66.6		
LS 8420DP-3	DPX5 14-22#	5	7/10	★	-	-	33.4	★	6.4	-	★	★	★	★	★	-	3000	48.3/57.1	74*33.2*66.6		
LS 8450DP-3	DPX5 14-22#	4	7/13	★	-	-	33.4	★	6.4	-	-	★	★	★	★	-	3000	59.1/57.9	74*33.2*66.6		
LS 8450DP-5	DPX5 14-22#	5	7/13	★	-	-	33.4	★	6.4	-	-	★	★	★	★	-	3000	59.1/57.9	74*33.2*66.6		
LS 8720DP	DPX5 14-22#	7	7/13	★	-	-	33.4	★	6.4	-	-	★	★	-	★	★	3000	59.1/57.9	74*33.2*66.6		
LS 8750DP	DPX5 14-22#	7	7/13	★	-	-	33.4	★	6.4	-	-	★	★	-	★	★	3000	59.1/57.9	74*33.2*66.6		



Three-speed adjustment of LED light source and needle supplement



**Self-produced electronic control, intelligent
USB port**

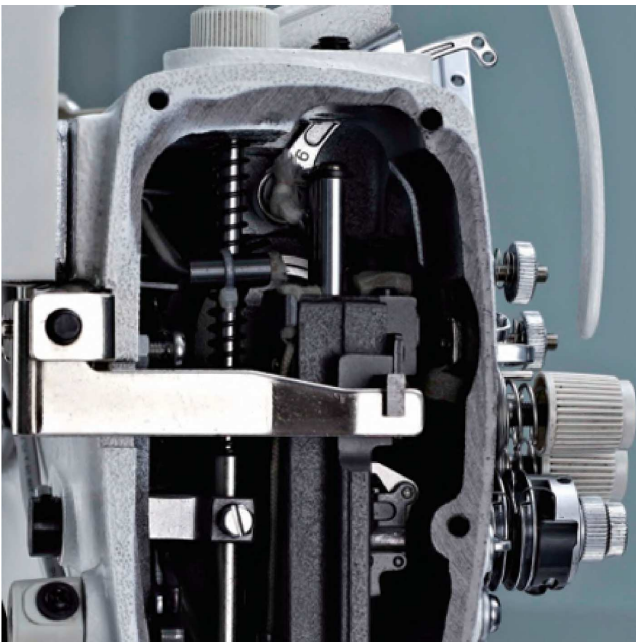

Micro oil for head



LS 202E-TD3/TD4-Computer Large Rotary Shuttle Heavy Material Lockstitch Sewing Machine

Lockstitch machine series

LS 202E-TD3	DPX5 100-160	37	8	8/16	★	★	★	★	★	★	★	2500	35/41	74*27*51
LS 202E-TD4	DPX5 160-160	37	8	8/16	★	★	★	★	★	★	★	2500	35/41	74*27*51
LS 202ECX-TD3	DPX5 160-160	37	12	8/16	★	★	★	★	★	★	★	2500	35/41	74*27*51



Equipped with electronic wire clamp



Big hook



big handwheel













round knife



LS 202DP-direct drive large hook heavy material lockstitch sewing machine

Lockstitch machine series

										
LS 202	DPX5 100-160	37	8	8/16	★	★	★	2500	28/35	63*26*56
LS 202DP	DPX5 100-160	37	8	8/16	★	★	★	2500	32/38	74*27*51
LS 202DPCX	DPX5 100-160	37	12	8/16	★	★	★	2500	32/38	74*27*51
LS 202CX	DPX5 100-160	37	12	8/16	★	★	★	2500	28/35	63*26*56



Simple integrated electronic control



Equipped with lighting function



Equipped with winder



LS 0303FE-TD3/TD4-up and down compound feeding stepping heavy material computer lockstitch sewing machine

Upper and lower compound feeding stepping heavy material computer lockstitch sewing machine

LS 0303FE-TD3	DPX17 110-180	37	0	3/15	★	★	★	★	★	★	★	2000	37/43	74*27*51
LS 0303FE-TD4	DPX17 110-180	37	5	3/15	★	★	★	★	★	★	★	2000	37/43	74*27*51



Electronic stitch, silent backstitch



Stepper motor control needle pitch



Voice navigation, one-key direct



round knife



LS 0303E-TD3/TD4-Upper and lower compound feeding heavy material computer lockstitch sewing machine

Lockstitch machine series

LS 0303E-TD3	DPX17 110-180	37	8	8/16	★	★	★	★	★	★	2000	37/43	74*27*51
LS 0303E-TD4	DPX17 110-180	37	8	8/16	★	★	★	★	★	★	2000	37/43	74*27*51
LS 0303ECX-TD3	DPX17 110-180	37	12	8/16	★	★	★	★	★	★	2000	37/43	74*27*51



Big hook



Integrated copy



Equipped with electronic wire clamp



big handwheel



LS 0303DP-Direct Drive Upper and Lower Compound Feed Heavy Material Lockstitch Sewing Machine

Lockstitch machine series

LS 0303	DPX17 110-180	37	8	8/16	★	★	★	—	★	2000	32/38	63*25*56
LS 0303CX	DPX17 110-180	37	12	8/16	★	★	★	★	★	2000	32/38	63*25*56
LS 0303DP	DPX17 110-180	37	8	8/16	★	★	★	—	★	2000	35/41	74*27*51
LS 0303DPCX	DPX17 110-180	37	12	8/16	★	★	★	—	★	2000	35/41	74*27*51



Simple integrated electronic control



Equipped with winder

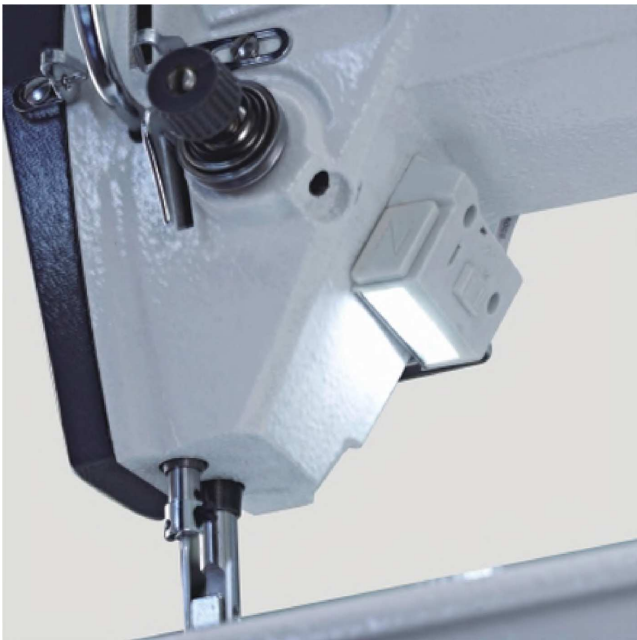

Equipped with lighting function



Pressure fine-tuning function



LS 640E-D3/D4-Upper and lower compound feed heavy material computer lockstitch sewing machine

Lockstitch machine series

LS 640E-D3	DPX17 110-180	38	9	6/16	★	★	★	★	★	★	2200	37/43	74*27*51
LS 640E-D4	DPX17 110-180	38	9	6/16	★	★	★	★	★	★	2200	37/43	74*27*51

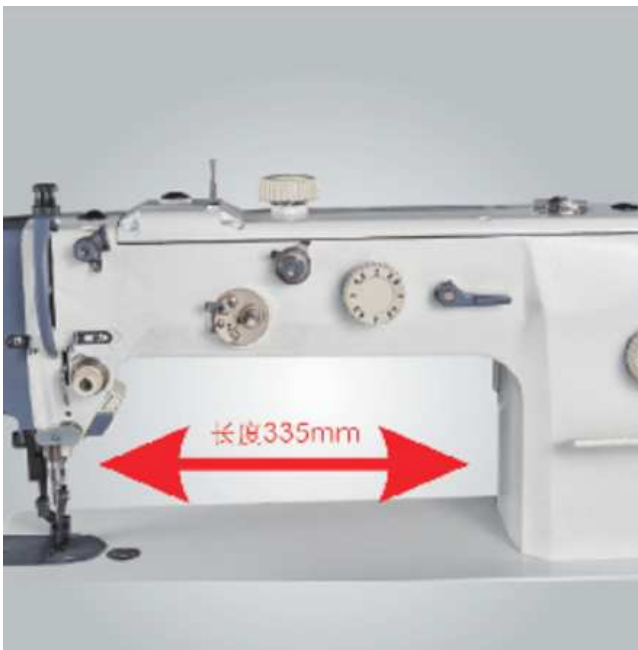

Large sewing space

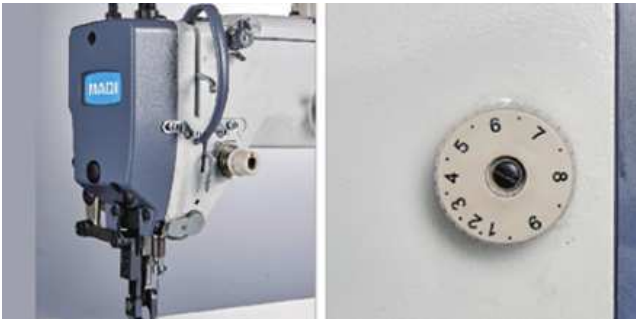

Large stroke thread take-up rod, stronger ability to eat thick



Needle distance up to 9mm

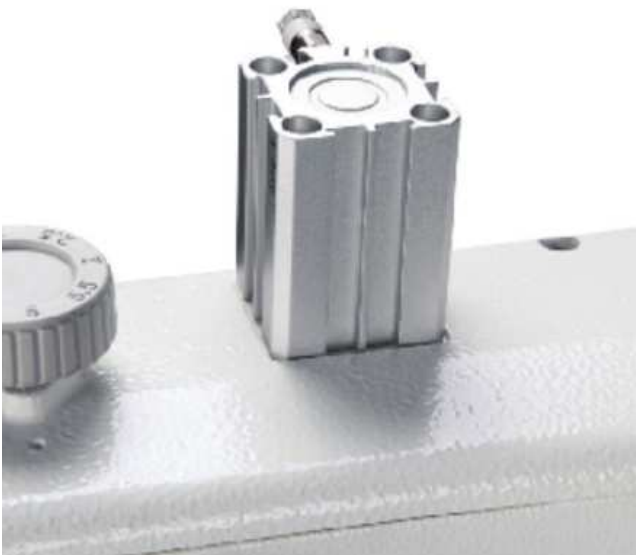

Pneumatic lifting foot structure



LS-H4400/H4420-Single-Needle/Double-Needle Combined Feed Thick Material Lockstitch Sewing Machine

Lockstitch machine series

LS-H4420	DPx17 18#-23#	2	2	6.4	★	0-9	★	★	8/16	36	2000	36.4/45	70.5*28*67.5	
LS-H4400	DPx17 18#-23#	1	1	—	★	0-9	★	★	8/16	36	2000	34.5/43.2	70.5*28*67.5	

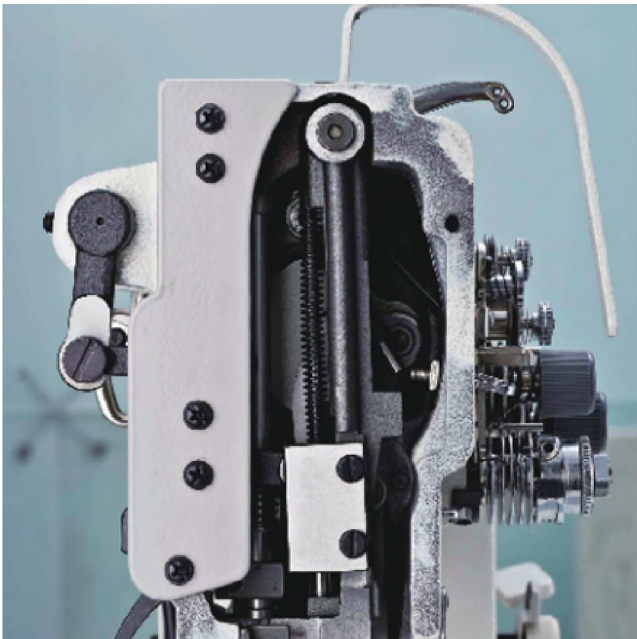

Integrated feeding structure



Plunger oil pump automatic lubrication

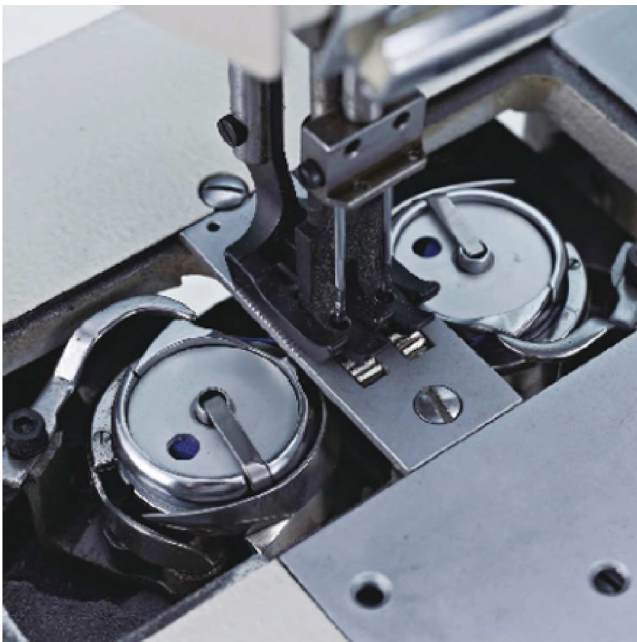

Heavy material vertical hook













High-intensity presser foot pressure

LS 3800D-PL-Chain Lockstitch Machine

Lockstitch machine series



										
LS 3810DP	TVX7 16#-21#	1.4-4	5/10	★	4	★	★	4000	36/46	63*25*57.5
LS 3820DP	TVX7 16#-21#	1.4-4	5/10	★	4	★	★	4000	36/46	63*25*57.5
LS 3830D-PL	UY128 16#-21#	1.4-4	5/10	★	6	★	★	4000	36/46	63*25*57.5
LS 4810DP	TVX7 16#-21#	1.4-4	5/10	★	2	★	★	4000	34/42	63*25*57.5
LS 3830DP	UY128 16#-21#	1.4-4	5/10	★	6	★	★	4000	36/46	63*25*57.5
LS 3800D-PL	TVX7 16#-21#	1.4-4	5/10	★	4	★	★	4000	36/46	63*25*57.5



Panel (roller panel)

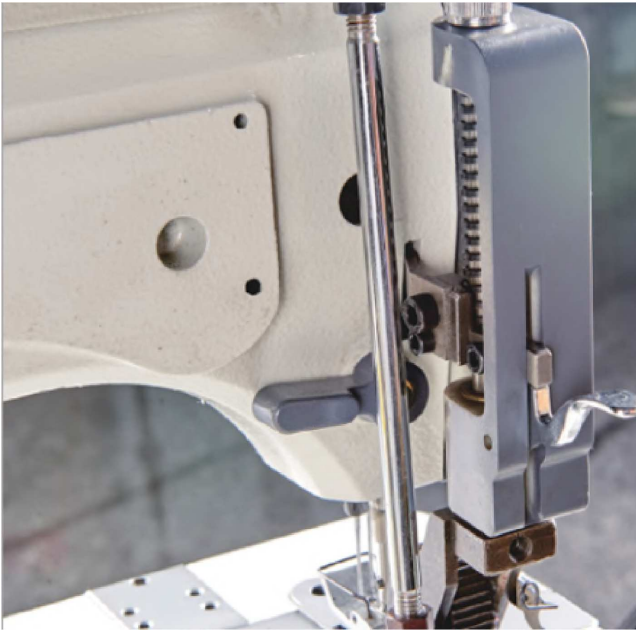

Linkage



low speed oil pump



Self-produced electronic control



looper mechanism

По вопросам продаж и поддержки обращайтесь:

Алматы (7273)495-231
Архангельск (8182)63-90-72
Астрахань (8512)99-46-04
Барнаул (3852)73-04-60
Белгород (4722)40-23-64
Брянск (4832)59-03-52
Владивосток (423)249-28-31
Волгоград (844)278-03-48
Вологда (8172)26-41-59
Воронеж (473)204-51-73
Екатеринбург (343)384-55-89
Иваново (4932)77-34-06
Ижевск (3412)26-03-58
Иркутск (395)279-98-46
Россия (495)268-04-70

Казань (843)206-01-48
Калининград (4012)72-03-81
Калуга (4842)92-23-67
Кемерово (3842)65-04-62
Киров (8332)68-02-04
Краснодар (861)203-40-90
Красноярск (391)204-63-61
Курск (4712)77-13-04
Липецк (4742)52-20-81
Магнитогорск (3519)55-03-13
Москва (495)268-04-70
Мурманск (8152)59-64-93
Набережные Челны (8552)20-53-41
Нижний Новгород (831)429-08-12
Киргизия (996)312-96-26-47

Новокузнецк (3843)20-46-81
Новосибирск (383)227-86-73
Омск (3812)21-46-40
Орел (4862)44-53-42
Оренбург (3532)37-68-04
Пенза (8412)22-31-16
Пермь (342)205-81-47
Ростов-на-Дону (863)308-18-15
Рязань (4912)46-61-64
Самара (846)206-03-16
Санкт-Петербург (812)309-46-40
Саратов (845)249-38-78
Севастополь (8692)22-31-93
Симферополь (3652)67-13-56
Казахстан (7172)727-132

Смоленск (4812)29-41-54
Сочи (862)225-72-31
Ставрополь (8652)20-65-13
Сургут (3462)77-98-35
Тверь (4822)63-31-35
Томск (3822)98-41-53
Тула (4872)74-02-29
Тюмень (3452)66-21-18
Ульяновск (8422)24-23-59
Уфа (347)229-48-12
Хабаровск (4212)92-98-04
Челябинск (351)202-03-61
Череповец (8202)49-02-64
Ярославль (4852)69-52-93